

# **Antenna Selection Guide for the IA4420 ISM Band FSK Transceiver**

**Application Note  
Version 1.0r - PRELIMINARY**

# INTEGRATION

Integration Associates, Inc.  
110 Pioneer Way, Unit L  
Mountain View, California 94041

Tel: 650.969.4100  
Fax: 650.969.4582  
[www.integration.com](http://www.integration.com)  
[marketing@integration.com](mailto:marketing@integration.com)  
[techsupport@integration.com](mailto:techsupport@integration.com)

Application Note: Antenna Selection Guide for the IA4420 ISM Band FSK  
Transceiver  
Version 1.0r - Preliminary  
Revision Date: December 15, 2005

The information is provided "as is" without any express or implied warranty of any kind, including warranties of merchantability, non-infringement of intellectual property, or fitness for any particular purpose. In no event shall Integration Associates, Inc., or its suppliers be liable for any damages whatsoever arising out of the use of or an inability to use the materials. Integration Associates, Inc., and its suppliers further do not warrant the accuracy or completeness of the information, text, graphics, or other items contained within these materials. Integration Associates, Inc., may make changes to these materials, or to the products described w/ithin, at any time, without notice.

© 2005 Integration Associates, Inc. All rights reserved. Integration Associates is a trademark of Integration Associates, Inc. All trademarks belong to their respective owners.

# ABOUT THIS GUIDE

---

The antenna selection guide for the IA4420 ISM Band FSK Transceiver is designed to give product designers a quick time-to-market approach for on-board antenna selection. The guide is designed to address geographic regulations covering the standard ISM FSK band frequencies; 315MHz, 434MHz, 868MHz, and 915MHz and to address the approximate range-versus-bandwidth to given antenna pairs.

For further information on the devices used in this publication, see the following datasheets:

**IA4420 Universal ISM Band Transceiver datasheet:    IA4420-DS**

# TABLE OF CONTENTS

---

<b>About this Guide.....</b>	<b>2</b>
<b>Introduction.....</b>	<b>5</b>
DESCRIPTION.....	5
<b>1. Antenna Pairs and Ranges.....</b>	<b>6</b>
U.S. REGULATIONS: 915MHZ, 434MHZ.....	7
<i>Table 1.1 Free space range [m] in the 915 MHz U.S. unlicensed band.....</i>	<i>7</i>
<i>Table 1.2 Free space range [m] in the 434 MHz U.S. unlicensed band.....</i>	<i>8</i>
EUROPEAN ETSI REGULATIONS: 868MHZ AND 434MHZ .....	9
<i>Table 1.3 Free space range [m] in the 915 MHz European unlicensed band .....</i>	<i>9</i>
<i>Table 1.4 Free space range [m] in the 434 MHz European unlicensed band .....</i>	<i>10</i>
BER VS. RANGE CURVES FOR THE U.S. 915MHZ BAND.....	11
Fig. 1.1.....	11
Fig. 1.2.....	11
Fig. 1.3.....	12
Fig. 1.4.....	13
Fig. 1.5.....	13
Fig. 1.6.....	14
Fig. 1.7.....	15
Fig. 1.8.....	15
Fig. 1.9.....	16
BER VS. RANGE CURVE FOR THE U.S. 434MHZ BAND.....	17
Fig. 10.....	17
BER VS. RANGE CURVES FOR THE E.U. 868MHZ BAND.....	18
Fig. 1.11.....	18
Fig. 1.12.....	18
Fig. 1.13.....	19
Fig. 1.14.....	20
Fig. 1.15.....	20
Fig. 1.16.....	21
Fig. 1.17.....	22
Fig. 1.18.....	22
Fig. 1.19.....	23
BER VS. RANGE CURVES FOR THE E.U. 434MHZ BAND.....	24
Fig. 1.20.....	24

<b>2. Antenna Layouts</b> .....	<b>25</b>
915 MHz BAND .....	26
915/868 MHz cross tapped loops:.....	26
Fig. 2.3a. 915-868 MHz cross tapped loop antenna: the “small” type. ....	26
Fig. 2.3b. 915-868 MHz cross tapped loop antenna, “small” type: top and bottom layer (top view) .....	26
Fig. 2.3c. 915-868 MHz cross tapped loop antenna, “small” type: zoomed antenna RF feeding points on top layer and DC feeding point on bottom layer.....	27
Fig. 2.3d. 915-868 MHz cross tapped loop antenna, “small” type: zoomed picture of printed capacitor top and bottom (top view) layers. ....	27
Fig. 2.4a. 915-868 MHz cross tapped loop antenna: the “big” type. ....	28
Fig. 2.4b. 915-868 MHz cross tapped loop antenna, “big” type: top layer and bottom layer (top view).....	28
Fig. 2.4c. 915-868 MHz cross tapped loop antenna, “big” type: zoomed antenna RF feeding points on top layer and DC feeding point on bottom layer.....	29
Fig. 2.4d. 915-868 MHz dual band cross tapped loop antenna, “big” type: zoomed picture of printed capacitor top and bottom (top view) layers. ....	29
915MHz BIFA:.....	30
Fig. 2.5a. 915 MHz BIFA antenna. Top layer . ....	30
Fig. 2.5b. 915 MHz BIFA antenna. Bottom layer (top view) and zoomed antenna RF feeding points on top layer.....	30
Fig. 2.5c. 915 MHz BIFA antenna. Zoomed picture of antenna DC feeding on the bottom (top view) layer.....	31
868 MHz BAND.....	32
915/868 MHz cross tapped loops:.....	32
868MHz BIFA:.....	32
Fig. 2.6a. 868 MHz BIFA antenna. Top layer . ....	32
Fig. 2.6b. 868 MHz BIFA antenna. Bottom layer (top view) and zoomed antenna RF feeding points on top layer.....	32
Fig. 2.6c. 868 MHz BIFA antenna. Zoomed picture of antenna DC feeding on the bottom (top view) layer.....	33
434 MHz BAND.....	34
434MHz cross tapped loop: .....	34
Fig. 2.7a. 434 MHz cross tapped loop antenna. ....	34
Fig. 2.7b. 434 MHz cross tapped loop antenna. Top and bottom layer (top view) .....	34
Fig. 2.7c. 434 MHz cross tapped loop antenna. Zoomed picture of antenna RF feeding points on the top layer and DC feeding on bottom layer .....	35
Fig. 2.7d. 434 MHz cross tapped loop antenna. Zoomed picture of printed capacitor top and bottom (top view) layers . ....	35
<b>Appendix</b> .....	<b>36</b>
APPENDIX A.....	36
EIRP and sensitivity for IA4420 with alternate antennas.....	36
APPENDIX B .....	38
Fig B.1. ....	38
Fig B.2. ....	38

# INTRODUCTION

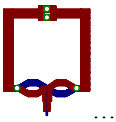
---

## DESCRIPTION

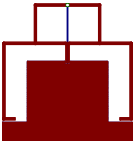
This document is an Antenna Selection Guide for the universal, four band (315MHz, 434MHz, 868MHz and 915MHz) IA4420 transceiver.

The document is an additional part of the IA-ISM-AN1 (Antenna selection Guide for IA4220 and IA4320) and the IA-ISM-AN2 (Antenna Development Guide for IA4220 and IA4320) documents. To download them visit our web site <http://www.integration.com>.

Within this document two antenna groups are referenced:



... Cross tapped loop antennas



Modified Inverted F (IFA) antennas, the so-called “back IFA” antennas

# 1. ANTENNA PAIRS AND RANGES

---

The range is estimated from the measured EIRP (Equivalent Isotropic Radiated Power) and sensitivity of the transmitter and the receiver with the different antennas, respectively. The definition of EIRP is given in Appendix A. During the range calculations, ideal free space propagation conditions were assumed with a propagation exponent of 2 and the formulas given in Appendix B of the IA-ISM-AN-1 document. The real ranges (indoor or outdoor) can be estimated from this data using the calculation method of Appendix E of the IA-ISM-AN-1 document. The reference distance ( $d_0$ ) during the measurements was 2m (see Appendix C of the IA-ISM-AN1 document for details).

The given range corresponds to a transmitter (TX) with two-sided FSK deviation of 120 kHz (with data rate of 9600 bps) and 180 kHz (with data rate of 57400 bps). The receiver (RX) baseband filter bandwidth was adjusted to 135 kHz. The EIRP data at TX mode and the sensitivity data (electric field strength) at RX mode in case of 10<sup>-2</sup>, 10<sup>-3</sup>, 10<sup>-4</sup> and 10<sup>-5</sup> BER with the different antennas are given in detail in Appendix A.

The receiver sensitivity was measured in the presence of strong interference (GSM, TV etc.) signals with frequencies close to the used bands (for details see Appendix D of the IA-ISM-AN1 document). The electric field of the interference signals around 900 MHz during the sensitivity measurements were between 60 and 80 mV/m; it is approx. 40-50 dB higher than the useful signal's electric field. As the receiver sensitivity is approx. 6-8 dB better in an interference-free environment (i.e., if a narrow band saw filter is used at the receiver input), the distance is about 2 times higher in that circumstance.

In the following tables the typical range to achieve a BER (Bit Error Rate) of 10<sup>-2</sup> in the case of various transmitter-receiver antenna pairs, is presented for 9600 and 57450 bps data rate at each frequency.

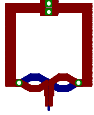
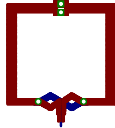
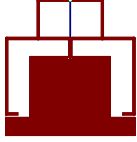
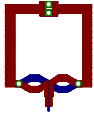
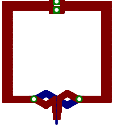
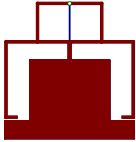
After the tables, the available free space ranges are given at several BER values (i.e. the BER vs. range curves) for different transmitter-receiver antenna pairs for 9600 and 57450 bps data rates at each frequency.

The antenna layouts together with the antenna dimensions are given in chapter 2.

## U.S. REGULATIONS: 915MHZ, 434MHZ

Tables 1.1, and 1.2 give the typical ideal free space ranges in meters for different antennas used in the TX and RX modules for the U.S. 915 MHz and 434 MHz band, respectively. A bit rate of 9600 bit/sec and 57400 bit/sec and a BER of  $10^{-2}$  was assumed during this estimation.

The transmitted power is regulated by part 15 of the FCC standards (Note 1). It gives restrictions to the allowed field strength at 3 m distances. The allowed field strengths are 50, and 11 mV/m at 915 and 434MHz, respectively. In case of spread spectrum transmission the maximum allowed TX power is 1 W at 915 MHz, which can be achieved only with an external booster stage.

915 MHz U.S. band	TX Xtapped Loop "small" (see Figs. 2.3)		TX Xtapped Loop "big" (see Figs. 2.4)		TX Back IFA (see Figs. 2.5)	
						
RX Xtapped loop "small" (see Figs. 2.3)	9600 bps	78	9600 bps	174	9600 bps	469
		57470 bps	41	57470 bps	92	249
RX Xtapped loop "big" (see Figs. 2.4)	9600 bps	184	9600 bps	413	9600 bps	1112
		57470 bps	123	57470 bps	276	743
RX Back IFA (see Figs. 2.5)	9600 bps	583	9600 bps	1306	9600 bps	3516
		57470 bps	348	57470 bps	778	2094

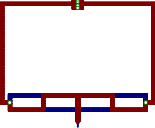
**Table 1.1 Free space range [m] in the 915 MHz U.S. unlicensed band ( $10^{-2}$  BER). The real indoor or outdoor ranges can be calculated from this data using the calculation method of Appendix E of the IA-ISM-AN1 document.**

**Note 1:** In an interference-free environment, the estimated ranges are approximately two times higher. In the case of non-ideal propagation, the ranges can dramatically decrease (see Appendix E of the IA-ISM-AN1 document for details).

**Note 2:** For further details on FCC part 15, see "Understanding the FCC Regulations for Low-Power, Non-Licensed Transmitters," by the Federal Communications Commission, available through the FCC Web site, <http://www.fcc.gov>, or via Integration's Design Resources page at <http://www.integration.com>.



**U.S. REGULATIONS: 915MHZ, 434MHZ (CONTINUED)**

<p>434 MHz U.S. band</p>	<p>TX Tapped Loop (see Figs. 2.7)</p>	
<p>RX Tapped loop (see Figs. 2.7)</p> 	<p>9600 bps</p>	<p>272</p>
	<p>57470 bps</p>	<p>192</p>

**Table 1.2 Free space range [m] in the 434 MHz U.S. unlicensed band ( $10^{-2}$  BER). The real indoor or outdoor ranges can be calculated from this data using the calculation method of Appendix E of the IA-ISM-AN1 document.**

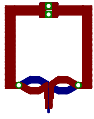
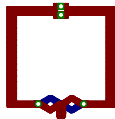
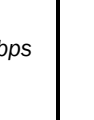
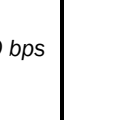
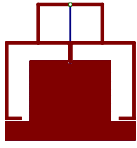
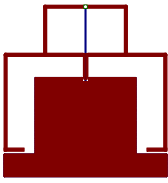
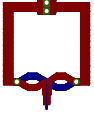
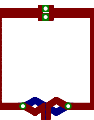
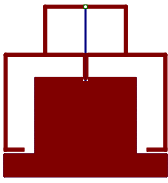
## EUROPEAN ETSI REGULATIONS: 868MHZ AND 434MHZ

The typical free space ranges for the 868 MHz and 434 MHz European unlicensed bands are given in Tables 1.3 & 1.4, respectively. The cross tapped loop antenna for 868 MHz is identical to that of the 915 MHz bands as the automatic tuning circuitry allows multi-band operation.

The allowed transmitter ERP is between 7-27 dBm (corresponding to 9.14-29.14 dBm EIRP) at 868 MHz depending on the sub-channel frequency. The allowed ERP is 10 dBm at 434 MHz (corresponding to 12.14 dBm EIRP).

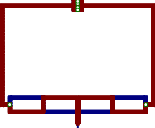
At 434 MHz the given back IFA TX antenna cannot approach the allowed 10 dB limit. Higher TX ERP and thus range can be achieved by applying IFA antennas with bigger dimensions or/and higher output current generated by an external booster stage.

The range can also be increased at 868 MHz by booster stages.

868 MHz E.U. band	TX Xtapped Loop "small" (see Figs. 2.3)		TX Xtapped Loop "big" (see Figs. 2.4)		TX Back IFA (see Figs. 2.5)	
						
RX Xtapped loop "small" (see Figs. 2.3)	9600 bps	57	9600 bps	114	9600 bps	390
	57470 bps	36	57470 bps	72	57470 bps	246
RX Xtapped loop "big" (see Figs. 2.4)	9600 bps	143	9600 bps	285	9600 bps	979
	57470 bps	85	57470 bps	170	57470 bps	583
RX Back IFA (see Figs. 2.5)	9600 bps	639	9600 bps	1276	9600 bps	4372
	57470 bps	381	57470 bps	760	57470 bps	2604

**Table 1.3 Free space range [m] in the 915 MHz European unlicensed band ( $10^{-2}$  BER). The real indoor or outdoor ranges can be calculated from this data using the calculation method of Appendix E of the IA-ISM-AN1 document.**

**EUROPEAN ETSI REGULATIONS: 868MHZ AND 434MHZ (CONTINUED)**

434 MHz E.U. band	TX Tapped Loop (see Figs. 2.7)	
RX Tapped loop (see Figs. 2.7) 	9600 bps	272
	57470 bps	192

**Table 1.4** Free space range [m] in the 434 MHz European unlicensed band ( $10^{-2}$  BER). The real indoor or outdoor ranges can be calculated from this data using the calculation method of Appendix E of the IA-ISM-AN1 document.

## BER VS. RANGE CURVES FOR THE U.S. 915MHZ BAND

The BER vs. range curves at the 915MHz U.S. band in case of ideal free space propagation conditions is given in Figs. 1.1.- 1.9. (for real ranges use the calculation method given in Appendix E of the IA-ISM-AN1 document).

The Figs 1.1. - 1.3. shows the ranges if the small cross tapped loop antenna is used as an RX antenna.

The Figs 1.4. - 1.6. shows the ranges if the big cross tapped loop antenna is used as an RX antenna.

The Figs 1.7. - 1.9. shows the ranges if the BIFA antenna is used as an RX antenna.

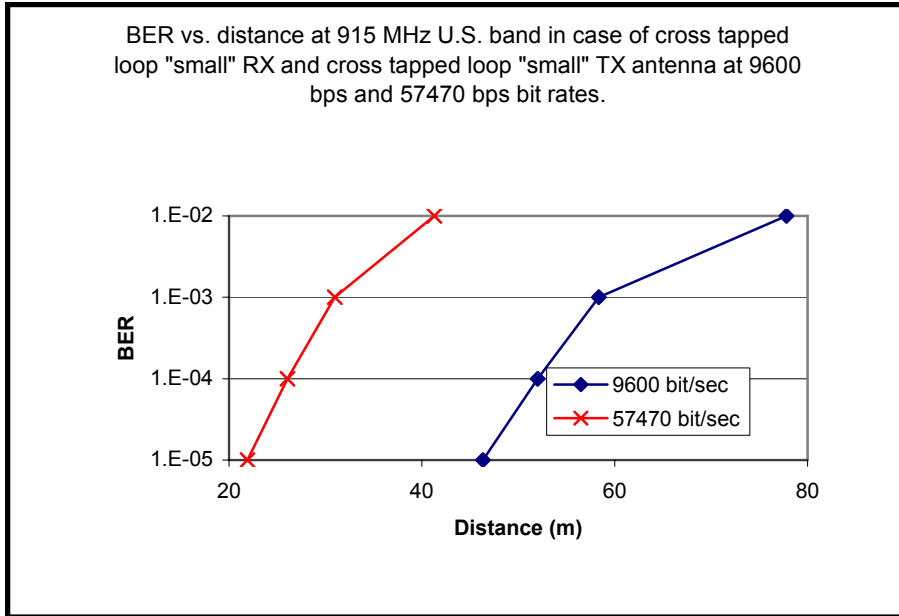


Fig. 1.1.

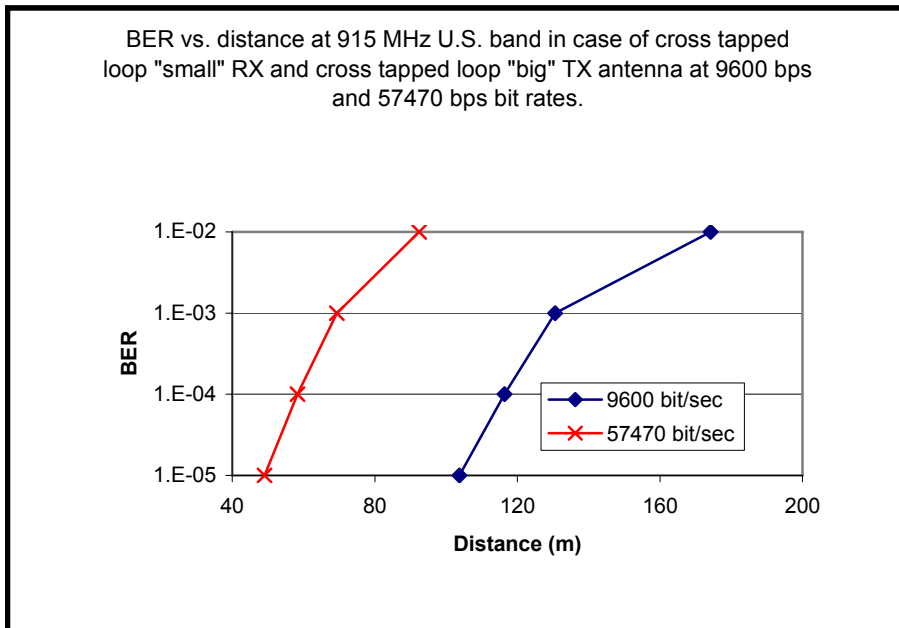


Fig. 1.2.

## BER VS. RANGE CURVES FOR THE U.S. 915MHZ BAND (CONTINUED)

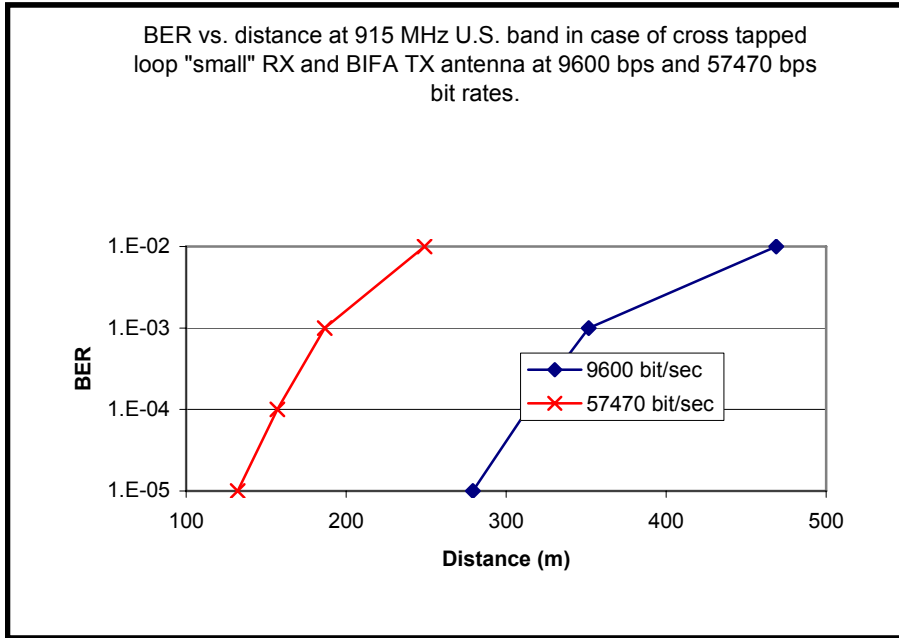


Fig. 1.3.

## BER VS. RANGE CURVES FOR THE U.S. 915MHZ BAND (CONTINUED)

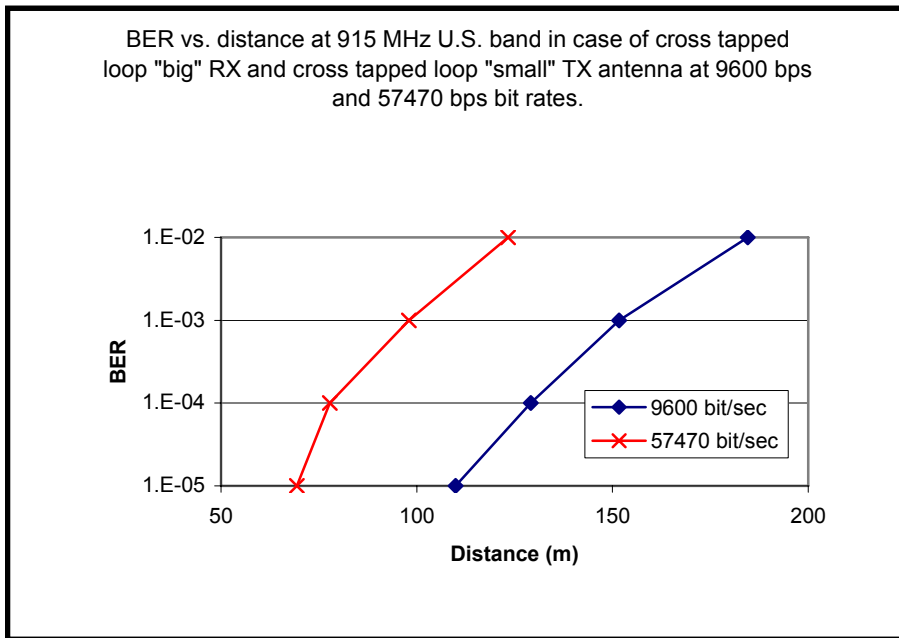


Fig. 1.4.

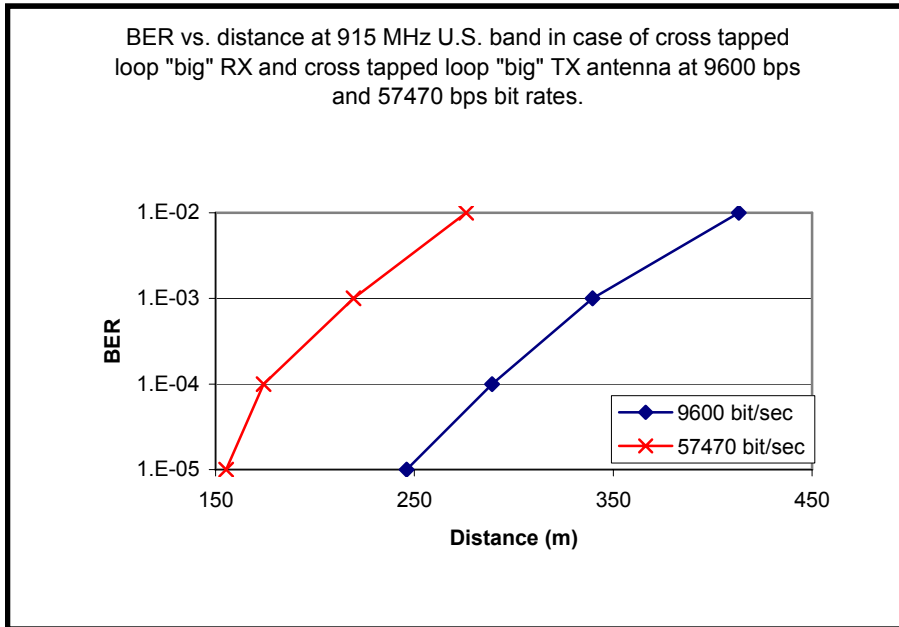


Fig. 1.5.

## BER VS. RANGE CURVES FOR THE U.S. 915MHZ BAND (CONTINUED)

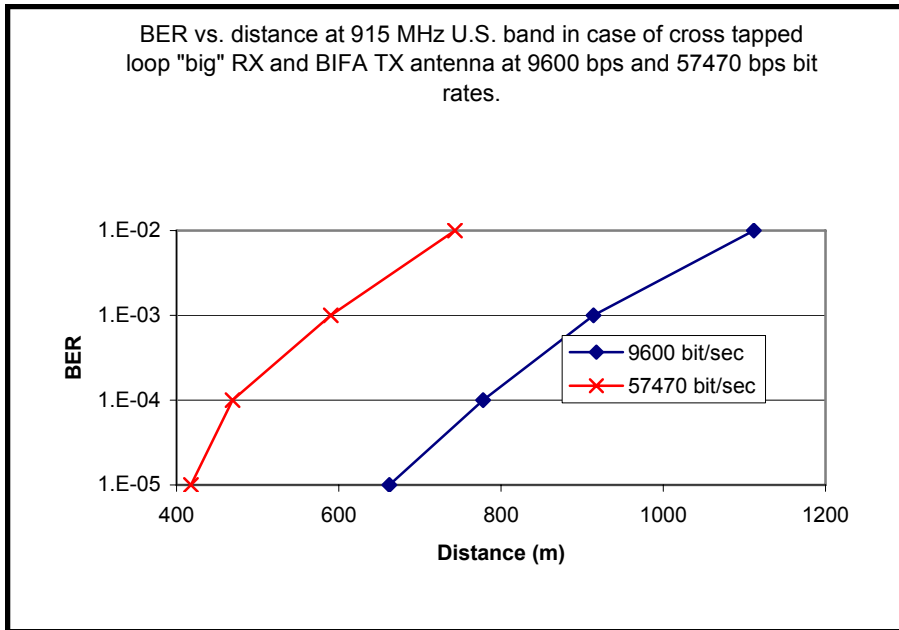


Fig. 1.6.

## BER VS. RANGE CURVES FOR THE U.S. 915MHZ BAND (CONTINUED)

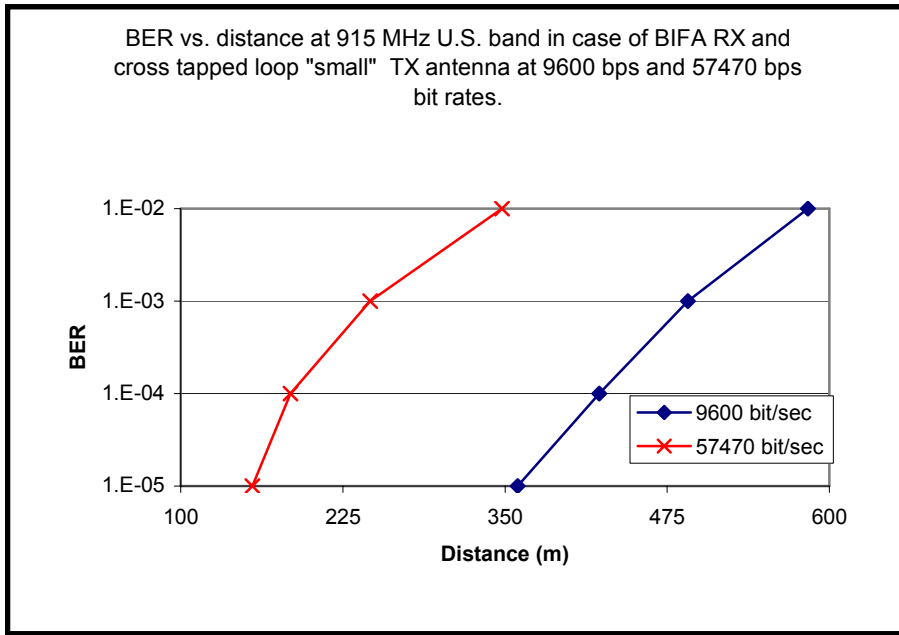


Fig. 1.7.

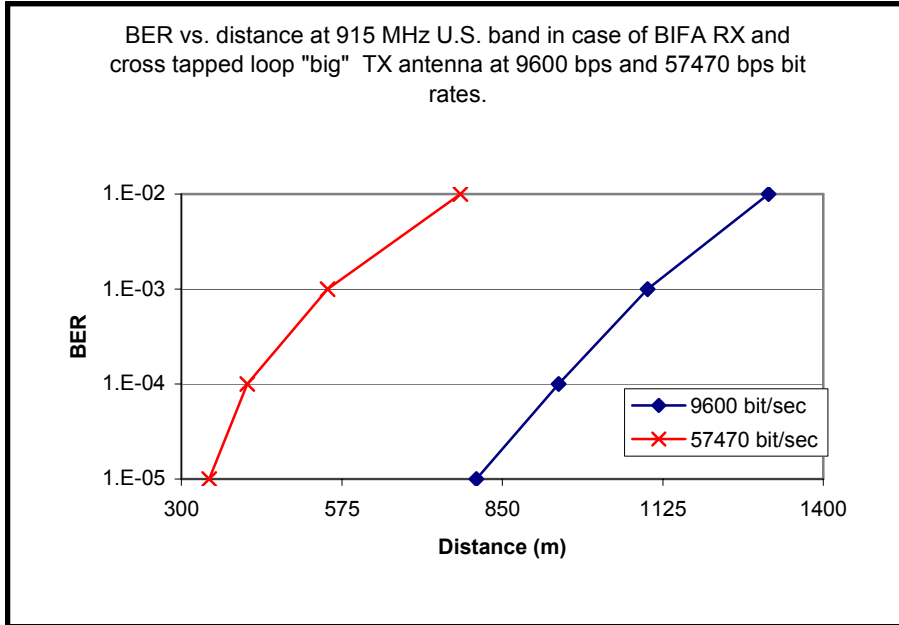


Fig. 1.8.



## BER VS. RANGE CURVES FOR THE U.S. 915MHZ BAND (CONTINUED)

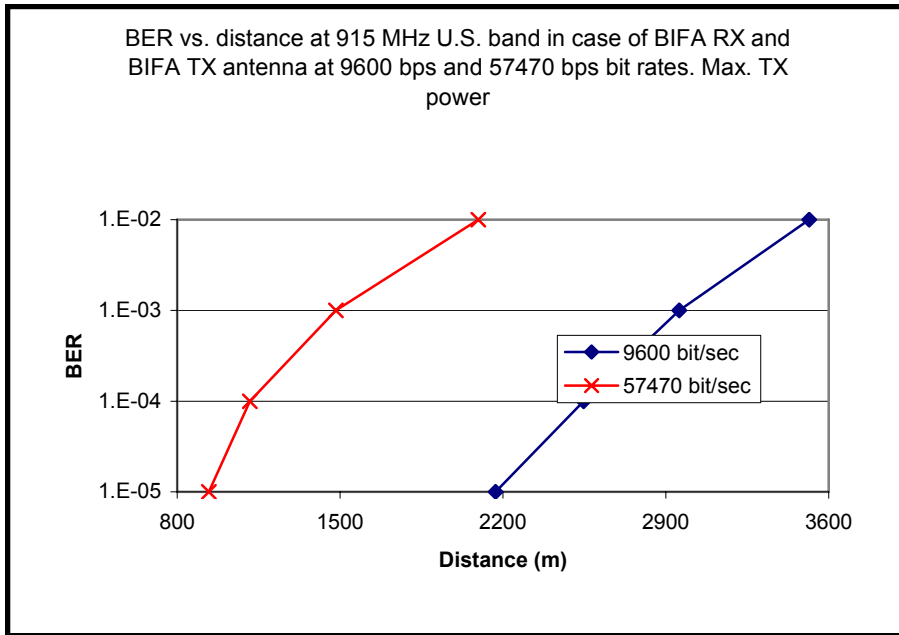


Fig. 1.9.

## BER VS. RANGE CURVE FOR THE U.S. 434MHZ BAND

The BER vs. range curves at the 434MHz U.S. band in case of ideal free space propagation conditions is given in Fig. 1.10 (for real ranges use the calculation method given in Appendix E of the IA-ISM-AN1 document).

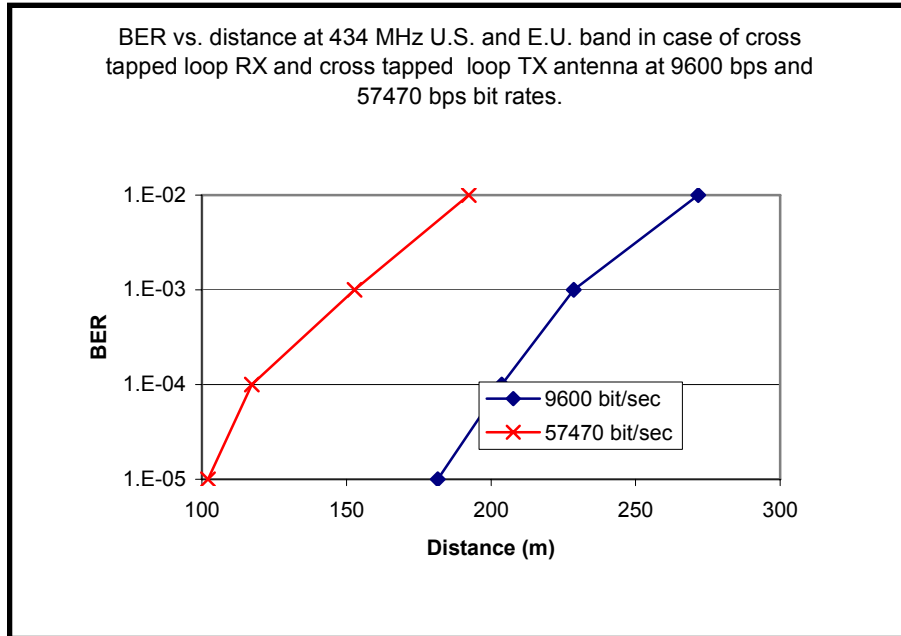


Fig. 10.

## BER VS. RANGE CURVES FOR THE E.U. 868MHZ BAND

The BER vs. range curves at the 868MHz European band in case of ideal free space propagation conditions is given in Figs. 1.11-1.19. (for real ranges use the calculation method given in Appendix E of the IA-ISM-AN1 document).

The Figs 1.11. - 1.13. shows the ranges if the small cross tapped loop antenna is used as an RX antenna.

The Figs 1.14. - 1.16. shows the ranges if the big cross tapped loop antenna is used as an RX antenna.

The Figs 1.17. - 1.19. shows the ranges if the BIFA antenna is used as an RX antenna.

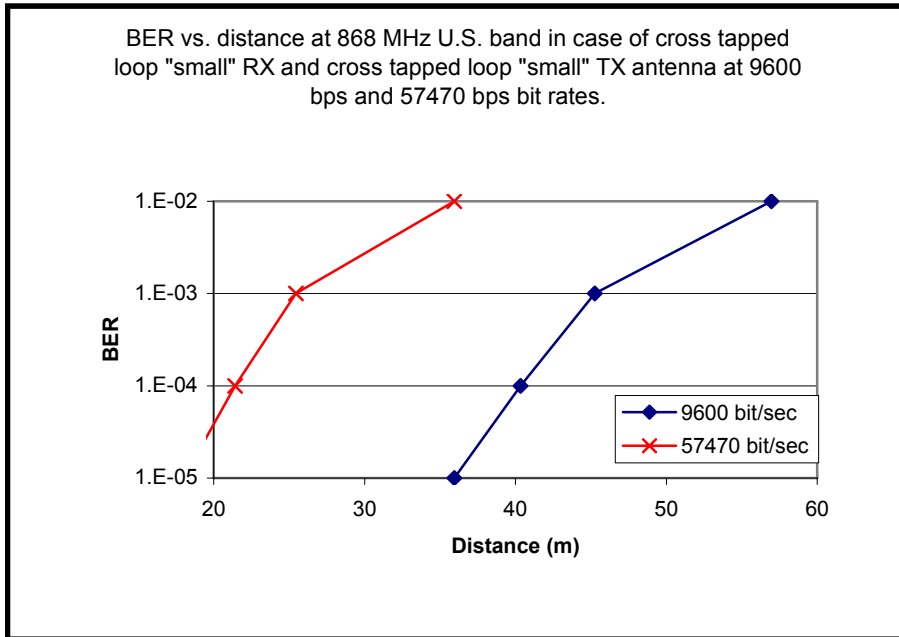


Fig. 1.11.

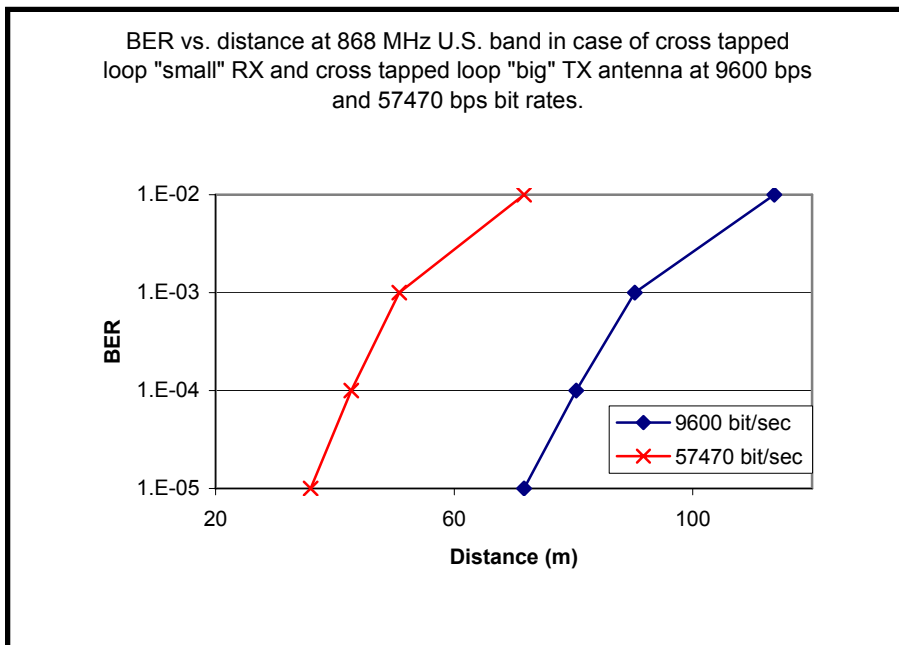


Fig. 1.12.

## BER VS. RANGE CURVES FOR THE E.U. 868MHZ BAND (CONTINUED)

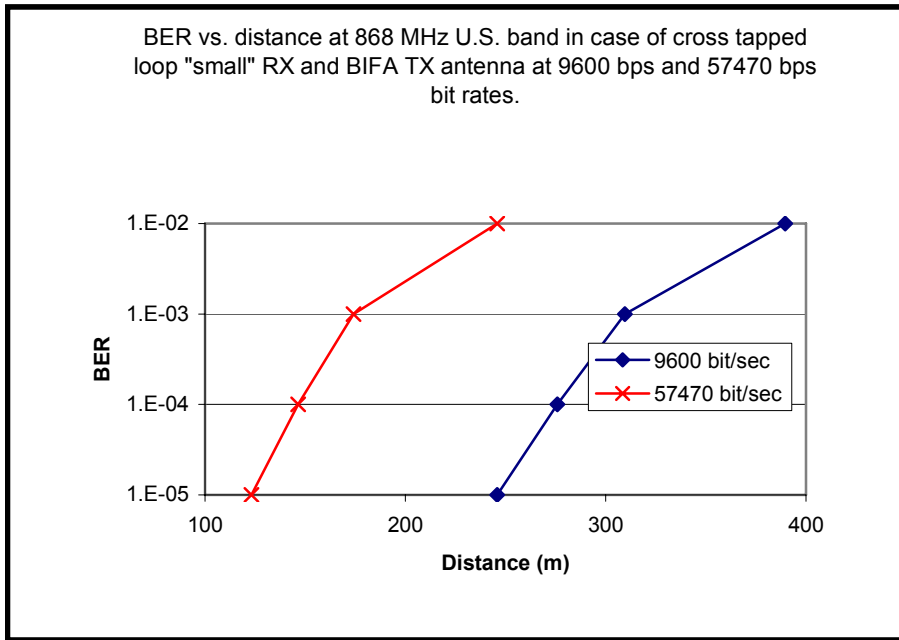


Fig. 1.13.

## BER VS. RANGE CURVES FOR THE E.U. 868MHZ BAND (CONTINUED)

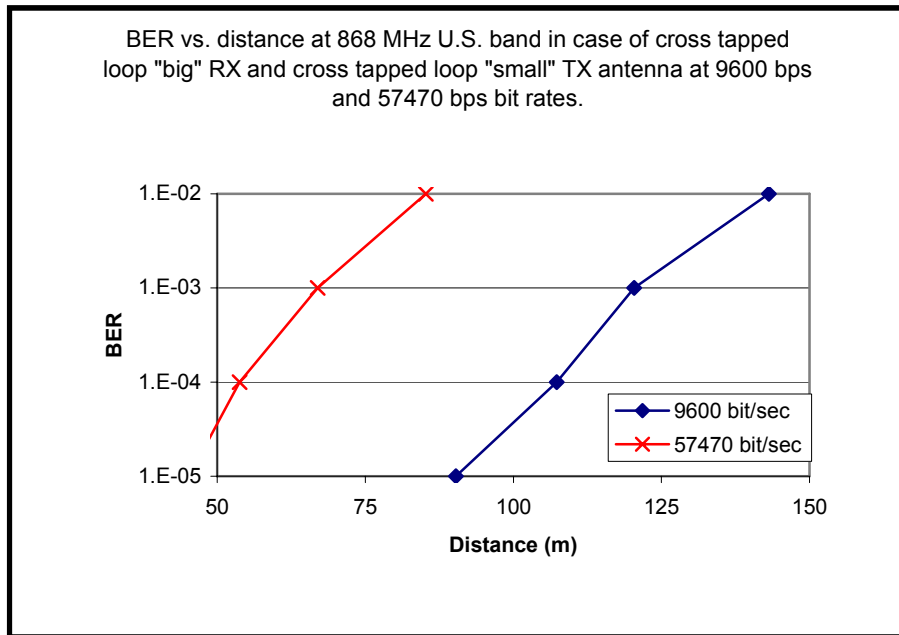


Fig. 1.14.

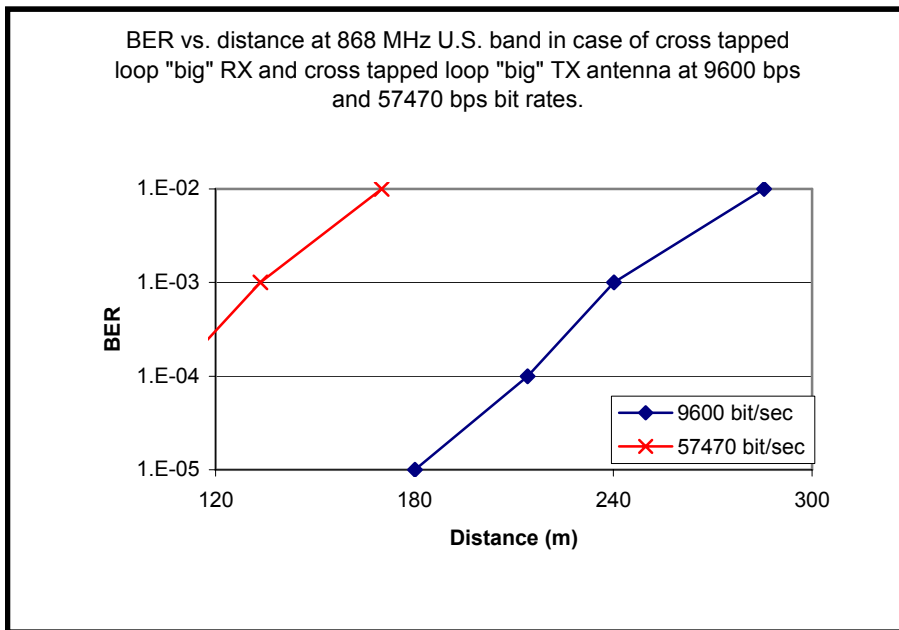


Fig. 1.15.

## BER VS. RANGE CURVES FOR THE E.U. 868MHZ BAND (CONTINUED)

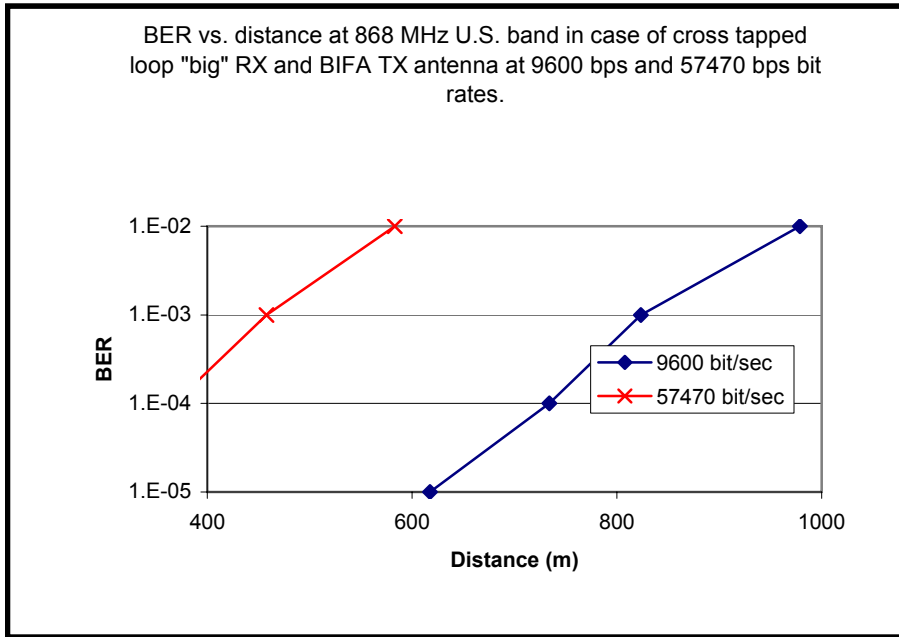


Fig. 1.16

## BER VS. RANGE CURVES FOR THE E.U. 868MHZ BAND (CONTINUED)

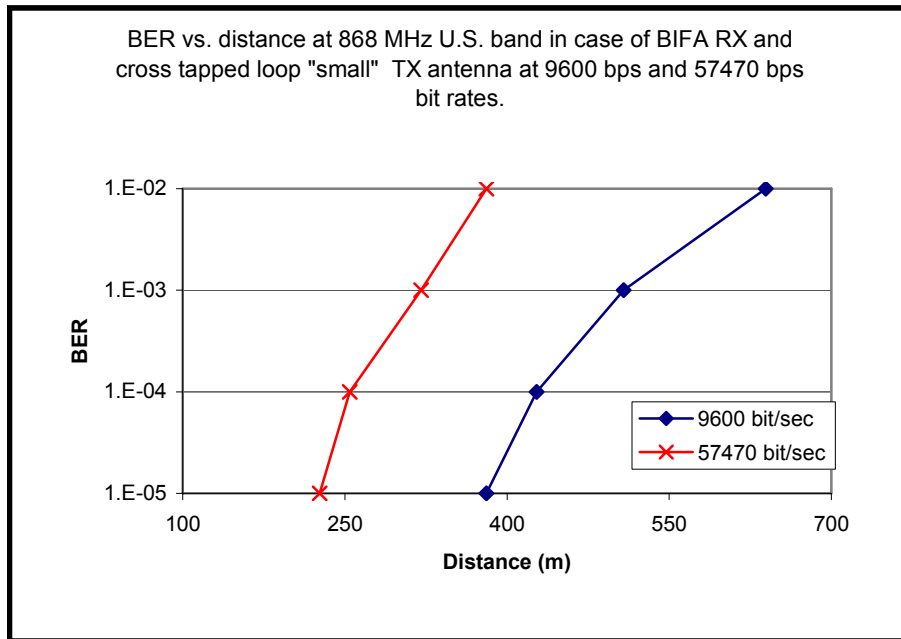


Fig. 1.17.

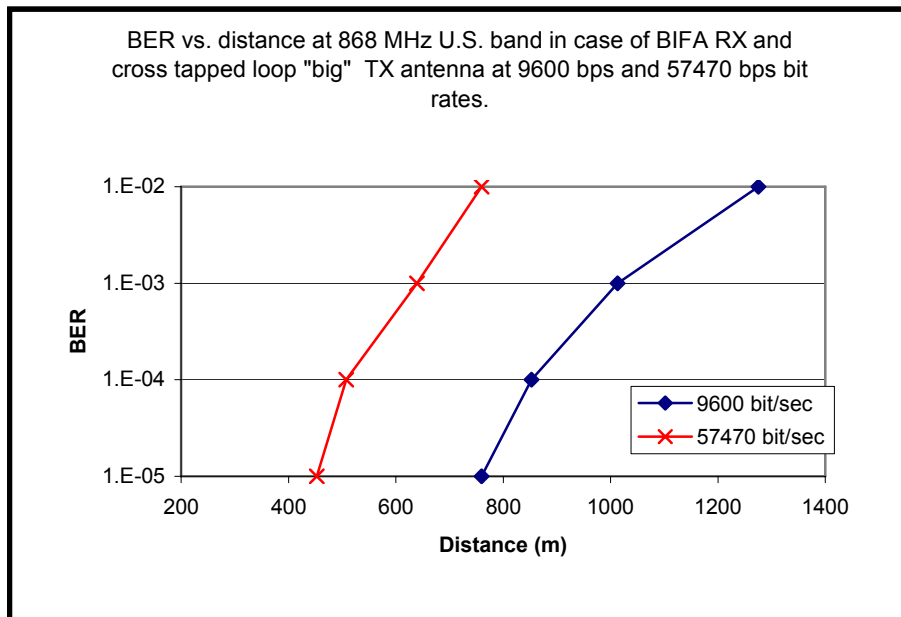


Fig. 1.18.

## BER VS. RANGE CURVES FOR THE E.U. 868MHZ BAND (CONTINUED)

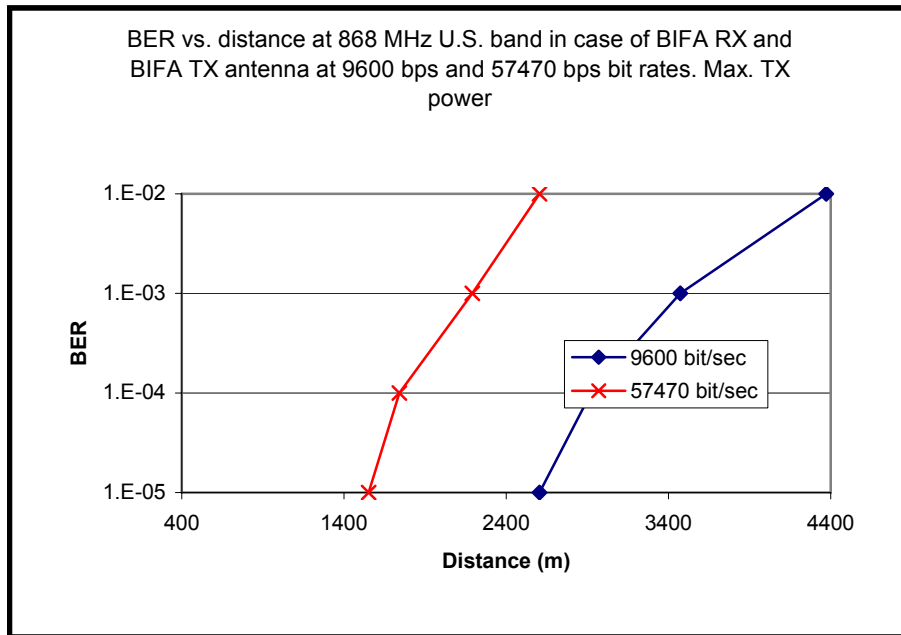


Fig. 1.19.



## BER VS. RANGE CURVES FOR THE E.U. 434MHZ BAND

The BER vs. range curves at the 434MHz European band in case of ideal free space propagation conditions is given in Fig. 1.20 (for real ranges use the calculation method given in Appendix E of the IA-ISM-AN1 document). The Fig. 1.20. is identical to Fig. 1.10. as the same antenna is used for the European and U.S. 434MHz band.

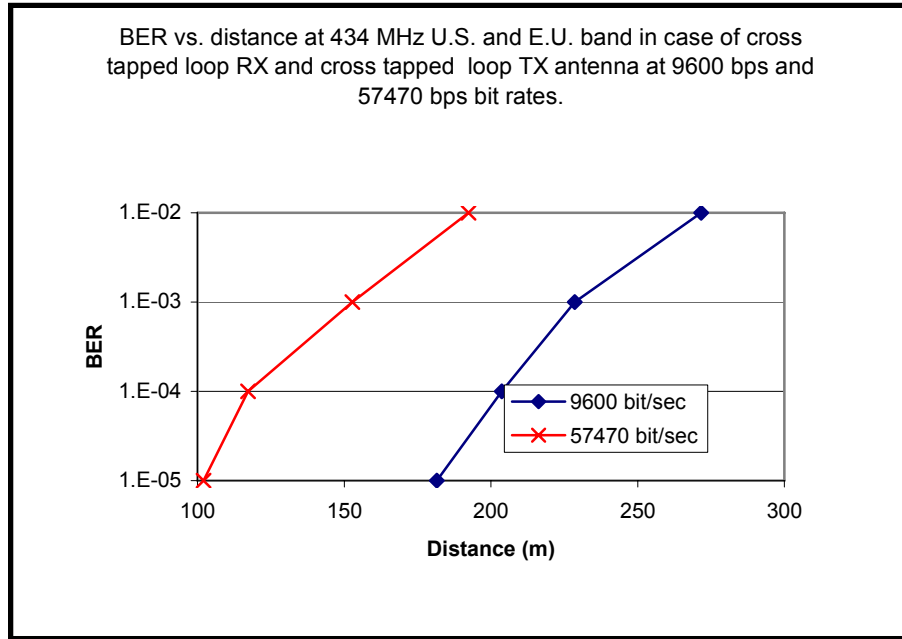


Fig. 1.20.

## 2. ANTENNA LAYOUTS

---

The used pcb material is FR4 (epsilon ~4.7) with a pcb thickness of 0.5mm in all antenna designs.

All antennas connected to the IA4420 outputs through 0.25mm wide feeding leads at the top layer (see e.g. Fig.2.3c, Fig.2.4c etc). The distance between the symmetry axes of the two leads is 0.75mm. At the feeding point this distance should be reduced to 0.635mm (to the pin distance of the IA4420 package (TSSOP 16)) by bending a 1mm long section of the leads at the chip.

The large shaded areas left from the antennas are the ground metal plate. Thus, in real life the gaps should be filled with ground metal areas devoted to the circuitry. But they are assumed to be a good RF. The ground metal areas at the top and bottom layer should be connected by several vias.

The vias shown in the antenna layouts has round shape and 0.5mm diameter.

The DC feed lead at the bottom layer is connected to a supply voltage area (to a so-called Vcc island). For example it can be observed in the right hand side figure of Fig. 2.3c. As the Vcc pin of the IA4420 is also connected to this, it should be also a good RF ground. Therefore, filtering capacitors should be soldered between the Vcc island and the neighboring ground metal close to the Vcc pin ( 100pF, 0603 SMD).

The input impedance of the BIFA antennas is very sensitive to the variation of the electrical length of the arms. The electrical length is changing either due to the spreading of the dielectric constant or due to the cutting of the pcb close to the arms. These effects can be compensated only slightly by the automatic antenna tuning. Thus, the physical cutting edge of the pcb should be at least 2mm away from the antenna arms.

The BIFA input impedance is also very sensitive to the length of the legs at the end of the antenna arms (the leg length determines the fringing tuning capacitor). The final sophisticated tuning of the antenna can be done by slightly (<0.5mm) varying the length of the legs.

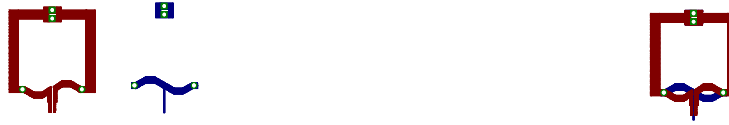
The above mentioned detuning effects are stronger in TX mode due to the higher Q.

## 915 MHZ BAND

### 915/868 MHz cross tapped loops:

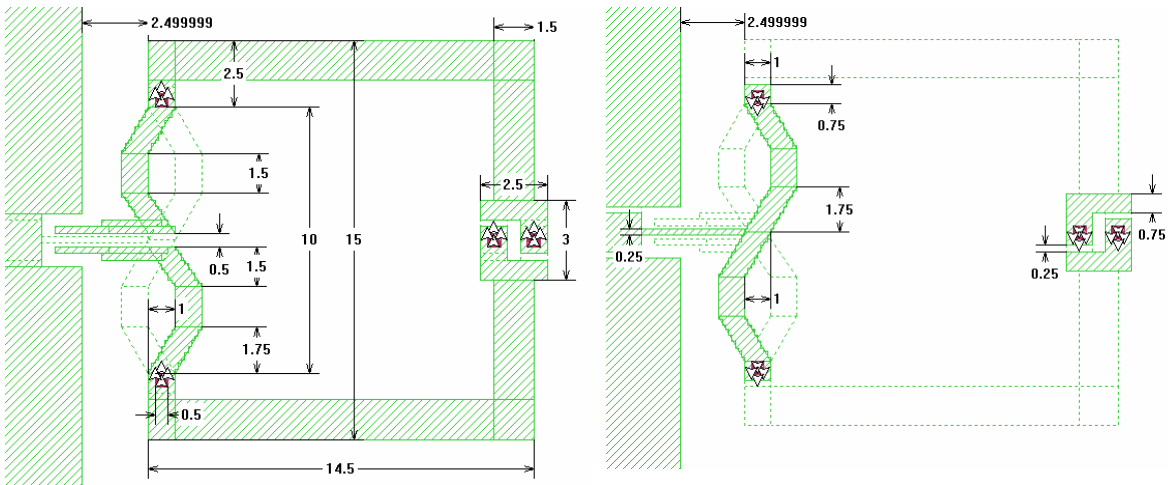
Two 915/868MHz cross tapped loop, a small one and a big one were designed and tested for the IA4420 chip.

The dimensions of the first “small” type is shown in Fig. 2.3a to Fig. 2.3d.



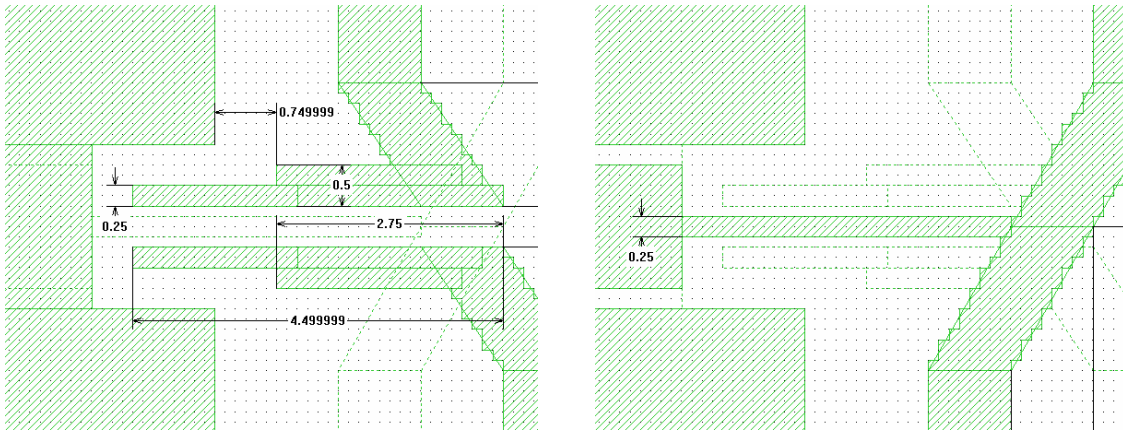
top and bottom view

**Fig. 2.3a. 915-868 MHz dual band cross tapped loop antenna: the “small” type.**

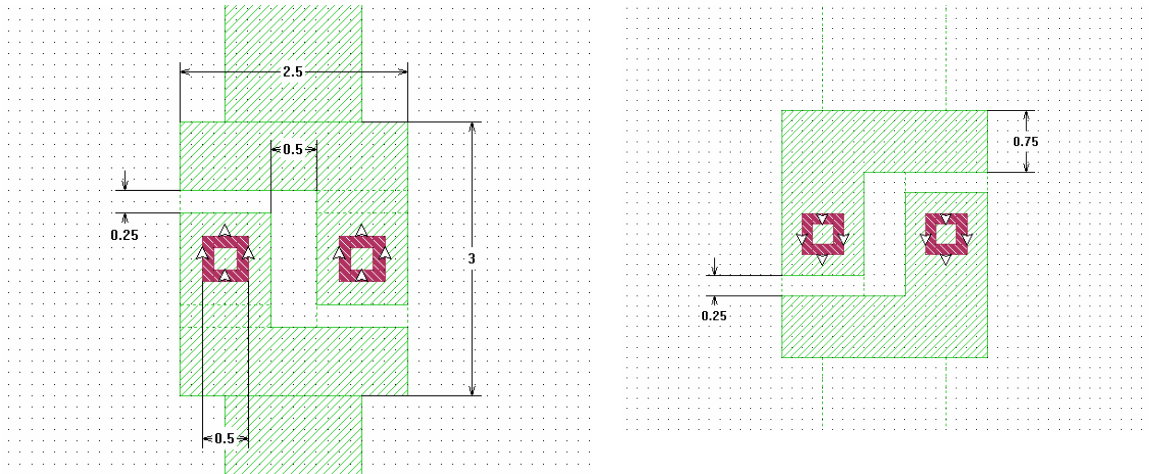


**Fig. 2.3b. 915-868 MHz dual band cross tapped loop antenna, “small” type: top and bottom layer (top view) (dimensions in mm).**

## 915 MHz BAND (CONTINUED)



**Fig. 2.3c.** 915-868 MHz dual band cross tapped loop antenna, “small” type: zoomed antenna RF feeding points on top layer and DC feeding point on bottom layer (dimensions in mm).



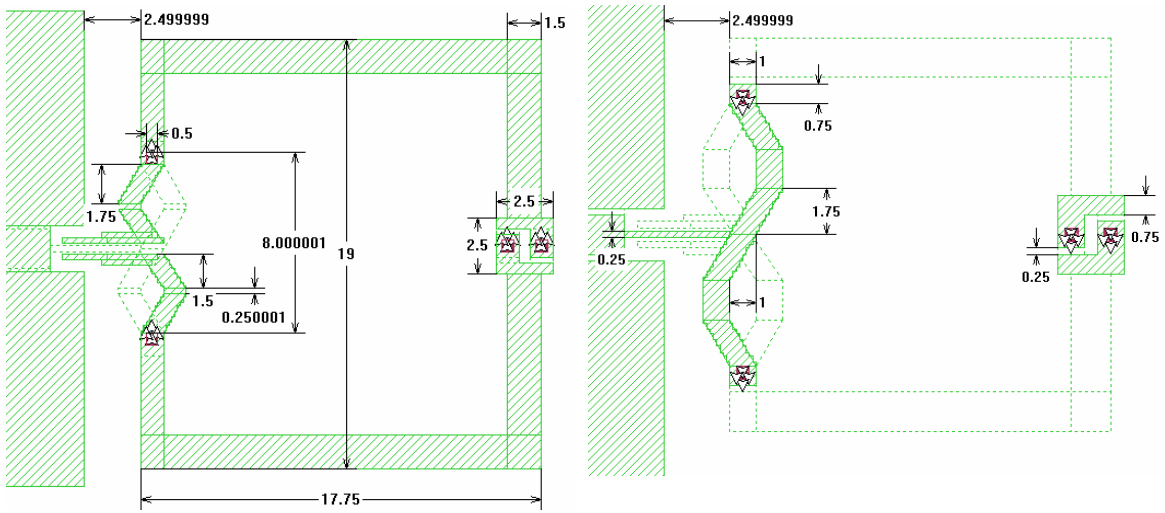
**Fig. 2.3d.** 915-868 MHz dual band cross tapped loop antenna, “small” type: zoomed picture of printed capacitor top and bottom (top view) layers (dimensions in mm).

## 915 MHz BAND (CONTINUED)

The dimensions of the second, "big" cross tapped loop antenna type. It is shown in Fig. 2.4a to Fig. 2.4d.

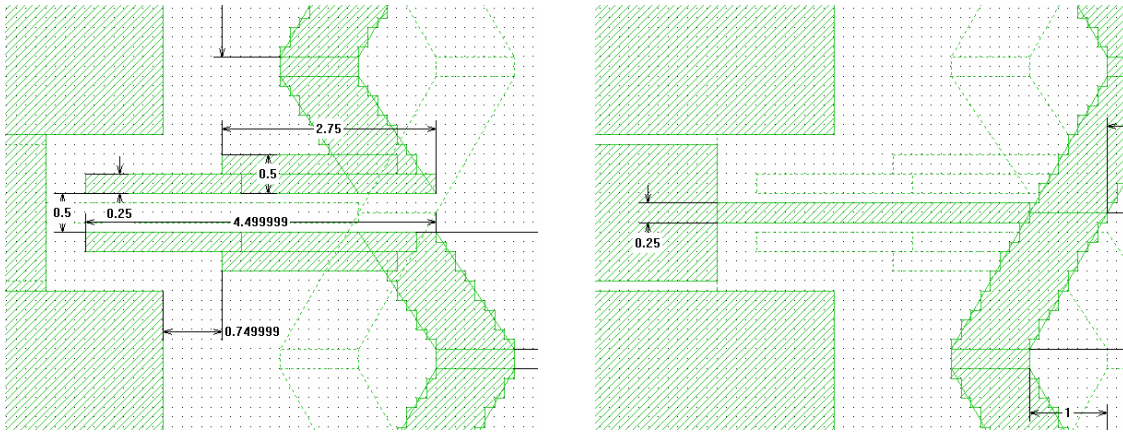


**Fig. 2.4a. 915-868 MHz dual band cross tapped loop antenna: the "big" type.**

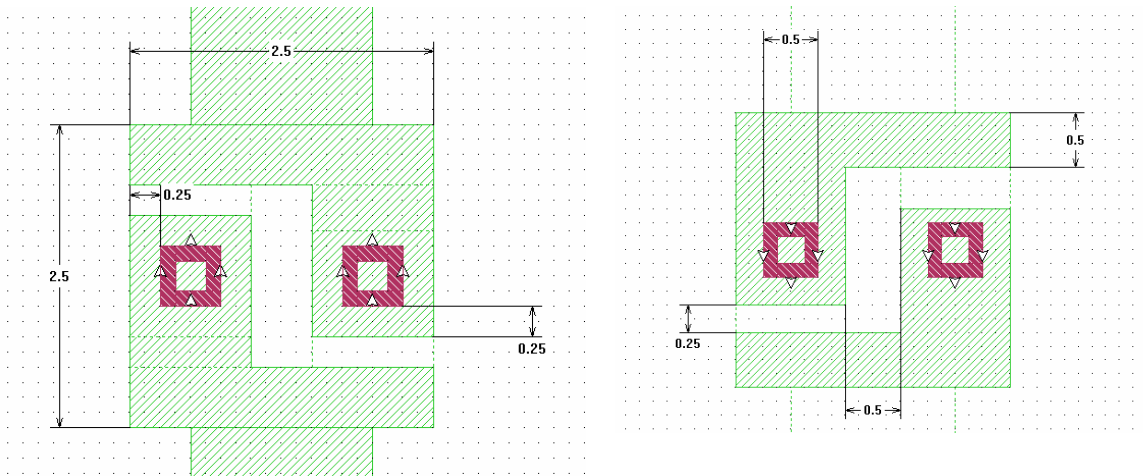


**Fig. 2.4b. 915-868 MHz dual band cross tapped loop antenna, "big" type: top layer and bottom layer (top view) (dimensions in mm).**

## 915 MHz BAND (CONTINUED)



**Fig. 2.4c.** 915-868 MHz dual band cross tapped loop antenna, “big” type: zoomed antenna RF feeding points on top layer and DC feeding point on bottom layer (dimensions in mm).

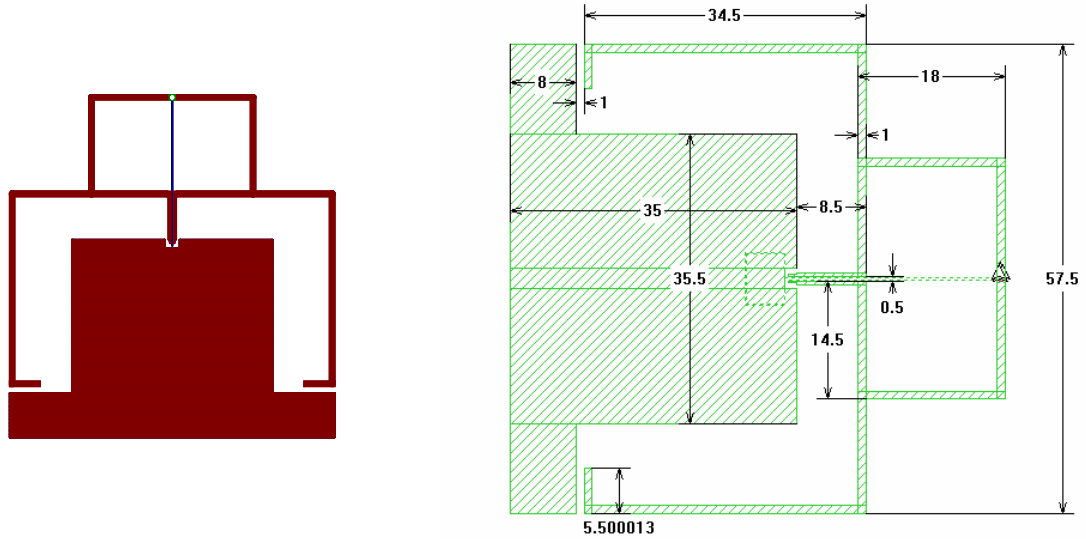


**Fig. 2.4d.** 915-868 MHz dual band cross tapped loop antenna, “big” type: zoomed picture of printed capacitor top and bottom (top view) layers (dimensions in mm).

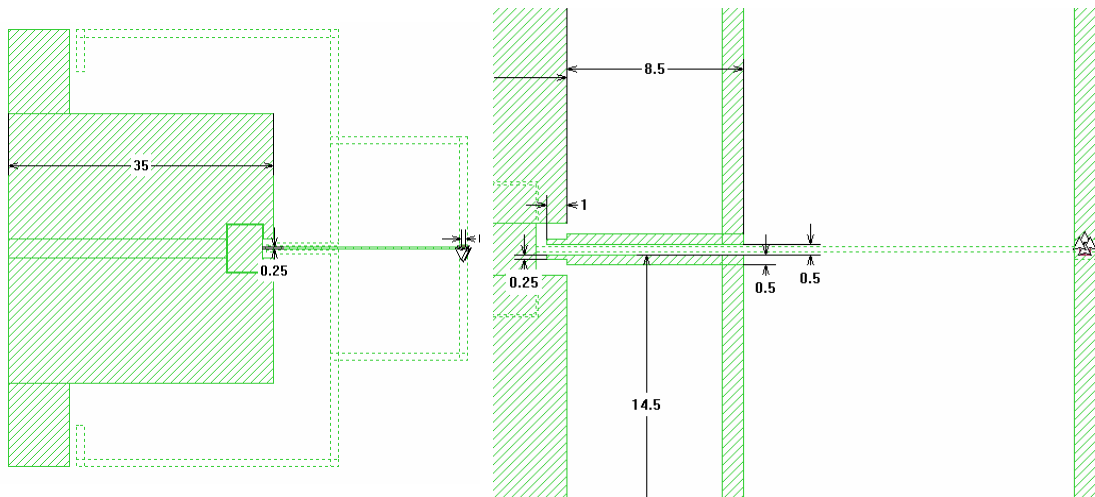
## 915 MHz BAND (CONTINUED)

### 915MHz BIFA:

Dimensions of the 915MHz BIFA is shown in Fig. 2.5a to 2.5c.

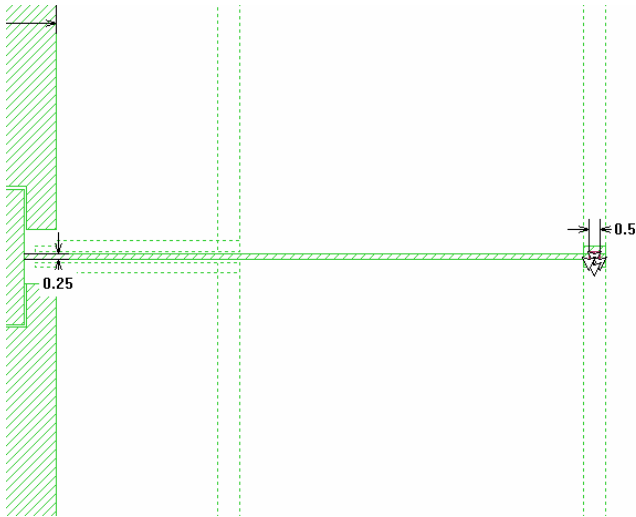


**Fig. 2.5a. 915 MHz BIFA antenna. Top layer (dimensions in mm).**



**Fig. 2.5b. 915 MHz BIFA antenna. Bottom layer (top view) and zoomed antenna RF feeding points on top layer (dimensions in mm).**

**915 MHz BAND (CONTINUED)**



**Fig. 2.5c. 915 MHz BIFA antenna. Zoomed picture of antenna DC feeding on the bottom (top view) layer (dimensions in mm).**



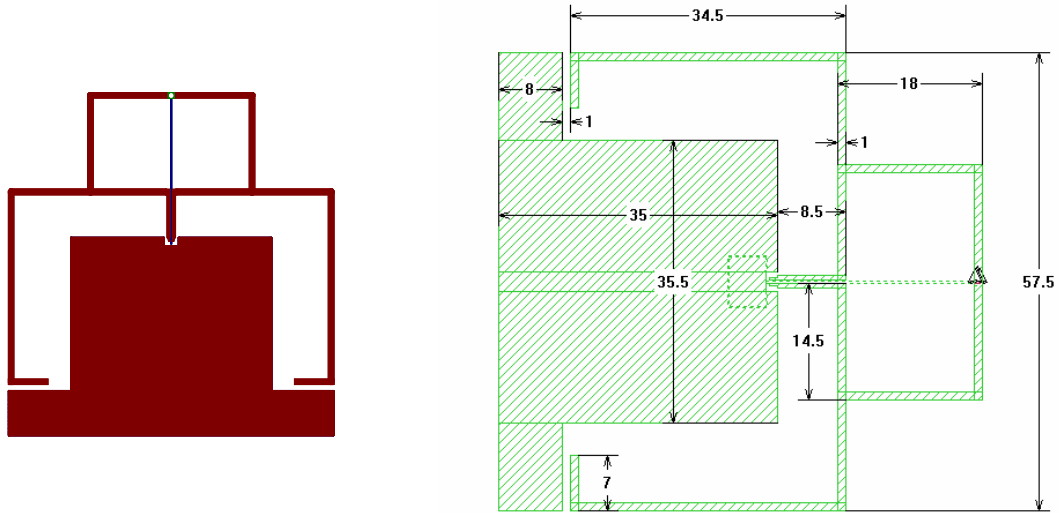
## 868 MHz BAND

### 915/868 MHz cross tapped loops:

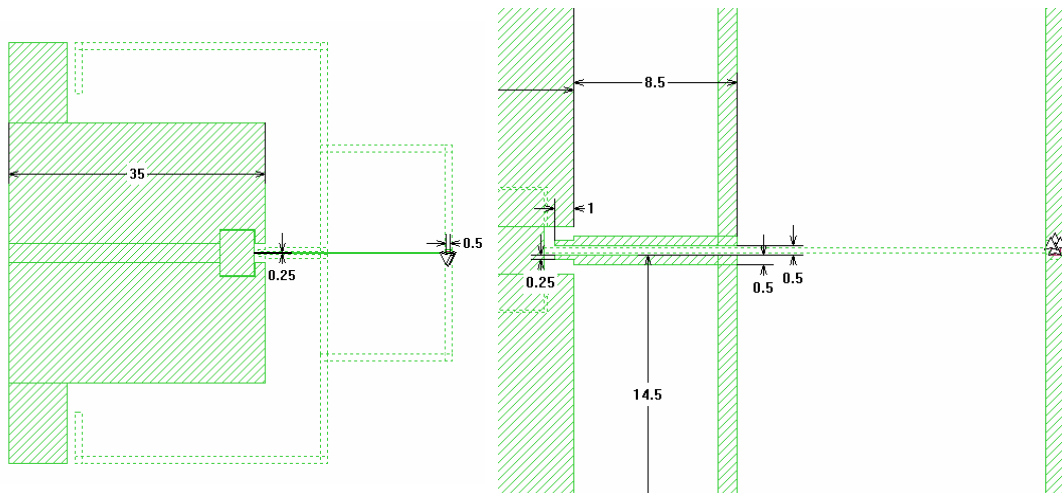
The two 915/868MHz cross tapped loops, are able to operate at 868 MHz as well. The “small” one is presented in Figs 2.3a, b, c. The “big” one is shown in Figs 2.4a, b, c.

### 868MHz BIFA:

Dimensions of the 868MHz BIFA is shown in Fig. 2.6a to 2.6c.

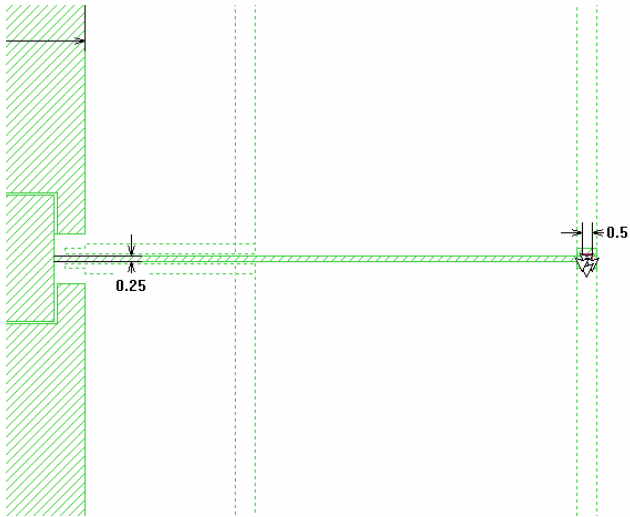


**Fig. 2.6a. 868 MHz BIFA antenna. Top layer (dimensions in mm).**



**Fig. 2.6b. 868 MHz BIFA antenna. Bottom layer (top view) and zoomed antenna RF feeding points on top layer (dimensions in mm).**

**868 MHz BAND (CONTINUED)**



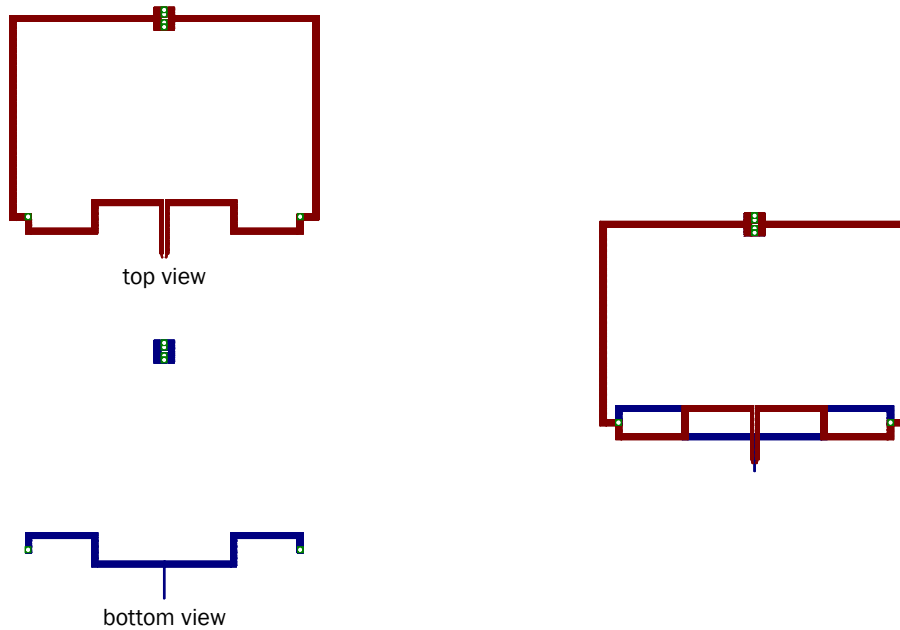
**Fig. 2.6c. 868 MHz BIFA antenna. Zoomed picture of antenna DC feeding on the bottom (top view) layer (dimensions in mm).**

## 434 MHz BAND

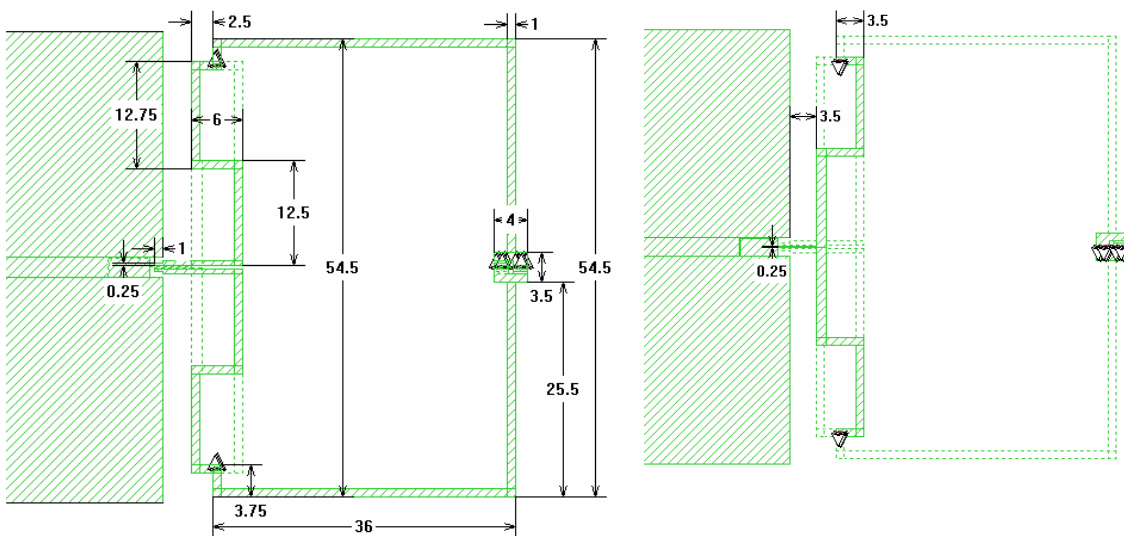
### 434MHz cross tapped loop:

A 434MHz cross tapped loop was designed and tested for the IA4420 chip.

The dimensions of the 434MHz cross tapped loop is shown in Fig. 2.7a to Fig. 2.7d.

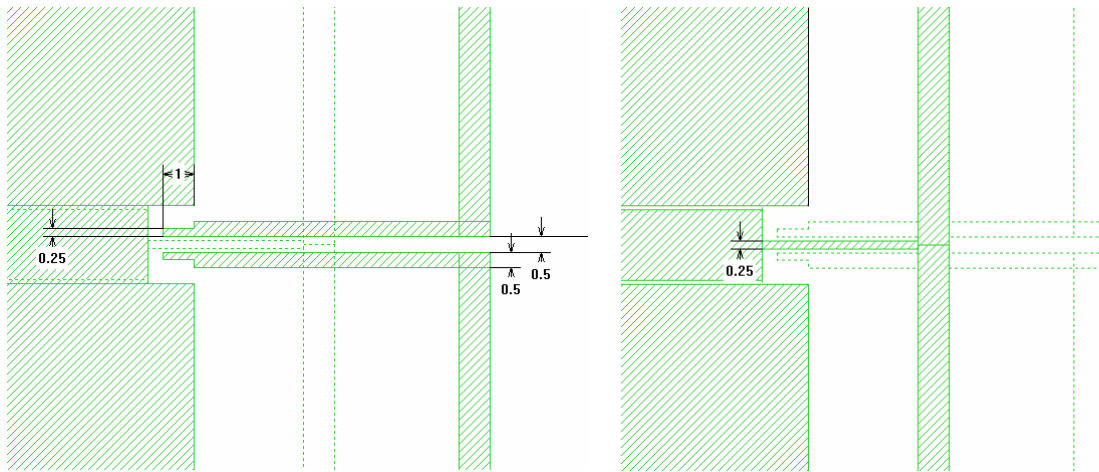


**Fig. 2.7a. 434 MHz cross tapped loop antenna.**

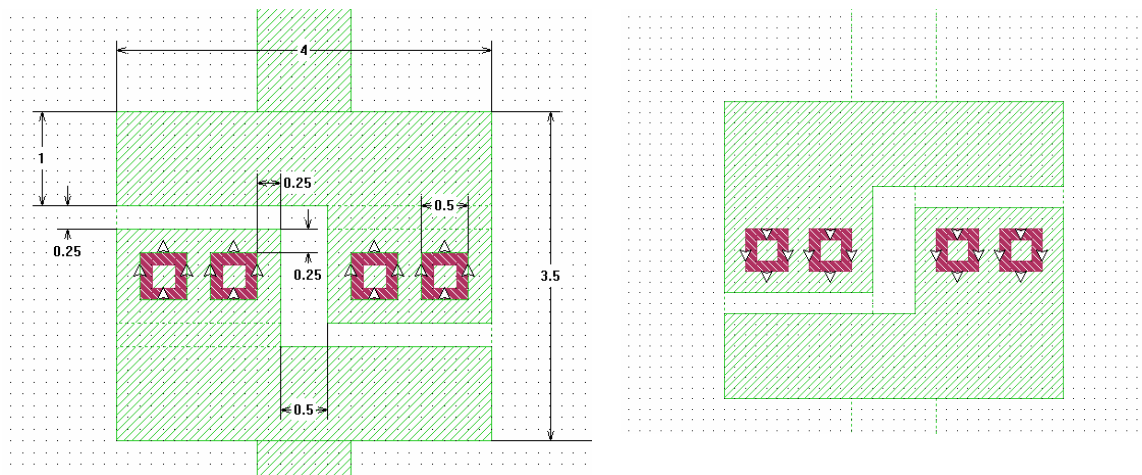


**Fig. 2.7b. 434 MHz cross tapped loop antenna. Top and bottom layer (top view) (dimensions in mm).**

## 434 MHz BAND (CONTINUED)



**Fig. 2.7c.** 434 MHz cross tapped loop antenna. Zoomed picture of antenna RF feeding points on the top layer and DC feeding on bottom layer (dimensions in mm).



**Fig. 2.7d.** 434 MHz cross tapped loop antenna. Zoomed picture of printed capacitor top and bottom (top view) layers (dimensions in mm).

# APPENDIX

## APPENDIX A

EIRP and sensitivity (electric field) values of IA4420 with different antennas

EIRP [dBm] ( $E_{rms3m}$ [mV/m])	IA4420 Antenna type		
	“Small” XLoop	“Big” XLoop	Back IFA
<b>915 MHz</b>	-16 (9)	- (21)	0.1 (58)
<b>868 MHz</b>	-16 (9)	-9.8 (19)	0.7 (62)
<b>434 MHz</b>	--	-14.6 (10.7)	--

**Table A.1. Maximum EIRP (Equivalent Isotropic Radiation Power) in dBm of the 4420 chip in TX mode with the above given antennas. The values in brackets are the generated electric field data at 3m distance in mV/m.**

Sensitivity ( $E_{rms}$ mV/m) $10^{-2}$ BER	IA4420 Antenna type					
	“Small” XLoop		“Big” XLoop		Back IFA	
	9600 bit/s	57470 bit/s	9600 bit/s	57470 bit/s	9600 bit/s	57470 bit/s
<b>915 MHz</b>	0.37	0.7	0.16	0.24	0.05	0.08
<b>868 MHz</b>	0.48	0.76	0.19	0.32	0.04	0.07
<b>434 MHz</b>	--	--	0.12	0.17	--	--

**Table A.2. Required effective electric field strength at the antenna of the TR 4420 chip in mV/m to achieve a BER of  $10^{-2}$  in case of RX mode. Strong interference is assumed (in an interference free environment half of the values are enough (6 dB better sensitivity)). The values are given at 9600 and 57470 bit/sec rates.**

Sensitivity ( $E_{rms}$ mV/m) $10^{-3}$ BER	IA4420 Antenna type					
	“Small” XLoop		“Big” XLoop		Back IFA	
	9600 bit/s	57470 bit/s	9600 bit/s	57470 bit/s	9600 bit/s	57470 bit/s
<b>915 MHz</b>	0.5	0.94	0.19	0.3	0.06	0.012
<b>868 MHz</b>	0.61	1.08	0.23	0.41	0.05	0.09
<b>434 MHz</b>	--	--	0.14	0.21	--	--

**Table A.3. Required effective electric field strength at the antenna of the TR 4420 chip in mV/m to achieve a BER of  $10^{-3}$  in case of RX mode. Strong interference is assumed (in an interference free environment half of the values are enough (6 dB better sensitivity)). The values are given at 9600 and 57470 bit/sec rates.**

# APPENDIX

## APPENDIX A (CONTINUED)

Sensitivity ( $E_{rms}$ mV/m) $10^{-4}$ BER	IA4420 Antenna type					
	"Small" XLoop		"Big" XLoop		Back IFA	
	9600 bit/s	57470 bit/s	9600 bit/s	57470 bit/s	9600 bit/s	57470 bit/s
<b>915 MHz</b>	0.56	1.12	0.23	0.37	0.07	0.16
<b>868 MHz</b>	0.68	1.28	0.26	0.51	0.06	0.11
<b>434 MHz</b>	--	--	0.16	0.28	--	--

**Table A.4. Required effective electric field strength at the antenna of the TR 4420 chip in mV/m to achieve a BER of  $10^{-4}$  in case of RX mode. Strong interference is assumed (in an interference free environment half of the values are enough (6 dB better sensitivity)). The values are given at 9600 and 57470 bit/sec rates.**

Sensitivity ( $E_{rms}$ mV/m) $10^{-5}$ BER	IA4420 Antenna type					
	"Small" XLoop		"Big" XLoop		Back IFA	
	9600 bit/s	57470 bit/s	9600 bit/s	57470 bit/s	9600 bit/s	57470 bit/s
<b>915 MHz</b>	0.63	1.33	0.26	0.42	0.08	0.19
<b>868 MHz</b>	0.76	1.52	0.3	0.61	0.07	0.12
<b>434 MHz</b>	--	--	0.18	0.32	--	--

**Table A.5. Required effective electric field strength at the antenna of the TR 4420 chip in mV/m to achieve a BER of  $10^{-5}$  in case of RX mode. Strong interference is assumed (in an interference free environment half of the values are enough (6 dB better sensitivity)). The values are given at 9600 and 57470 bit/sec rates.**

# APPENDIX

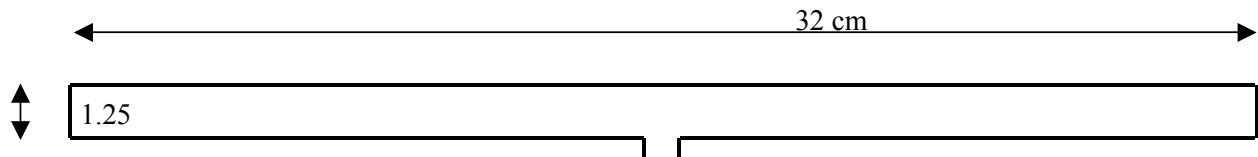
---

## APPENDIX B

### Preliminary folded dipole wire antennas for IA4420

#### 434MHz Folded dipole:

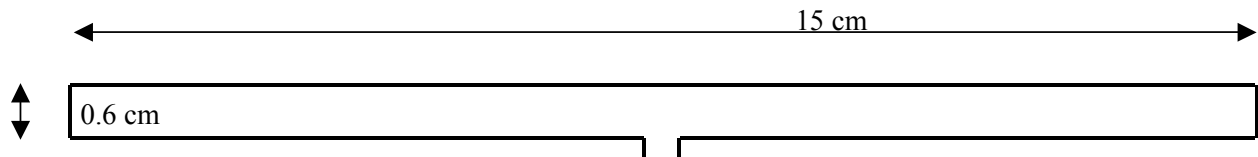
This is the best RX antenna for IA4420. The sensitivity is better by 1..2 dB than with the BIFA. However, the TX power is lower by ~4 dB. The dimensions of a 434MHz folded dipole made of wire is shown in Fig. B.1.



**Fig B.1.**

#### 915MHz Folded dipole:

This is the best RX antenna for IA4420. The sensitivity is better by 1..2 dB than with the BIFA. However, the TX power is lower by ~4 dB. The dimensions of a 915MHz folded dipole made of wire is shown in Fig. B.2.



**Fig B.2.**

Integration Associates, Inc.  
110 Pioneer Way, Unit L  
Mountain View, California 94041  
Tel: 650.969.4100  
Fax: 650.969.4582  
www.integration.com  
info@integration.com  
techsupport@integration.com

This document may contain preliminary information and is subject to change by Integration Associates, Inc. without notice. Integration Associates assumes no responsibility or liability for any use of the information contained herein. Nothing in this document shall operate as an express or implied license or indemnity under the intellectual property rights of Integration Associates or third parties. The products described in this document are not intended for use in implantation or other direct life support applications where malfunction may result in the direct physical harm or injury to persons. NO WARRANTIES OF ANY KIND, INCLUDING, BUT NOT LIMITED TO, THE IMPLIED WARRANTIES OF MECHANICALITY OR FITNESS FOR A PARTICULAR PURPOSE, ARE OFFERED IN THIS DOCUMENT.

©2005 Integration Associates, Inc. All rights reserved. Integration Associates is a trademark of Integration Associates, Inc. All other trademarks belong to their respective owners.